

RoHS Compliant

Halogen Free

REV	DESCRIPTION	ECN/ECR	DATE	DRAWN BY
△	新訂圖面	—	03/26/2018	王奔

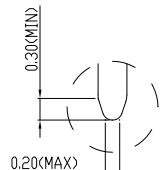

VIEW A SCALE 5:1

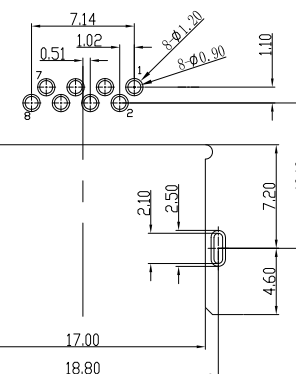
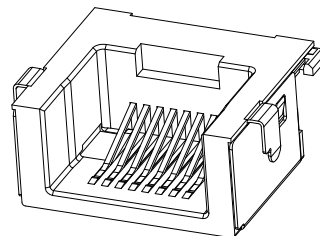
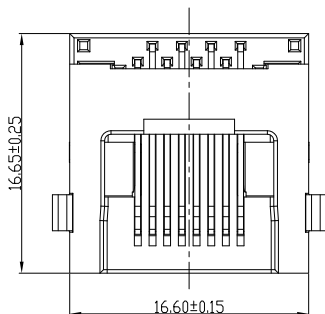

RECOMMENDED PCB LAYOUT
TOP VIEW: TOL:±0.05mm

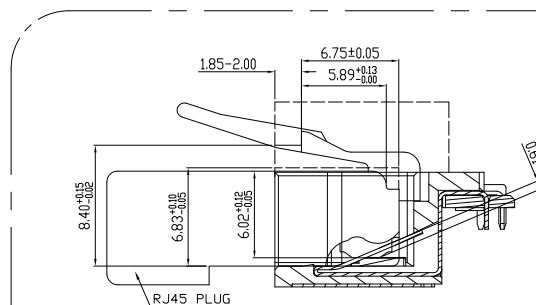
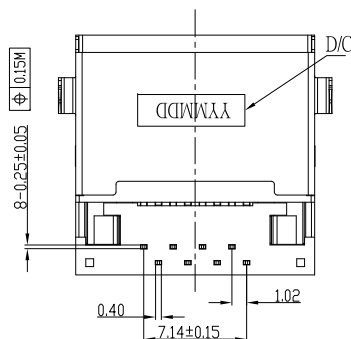
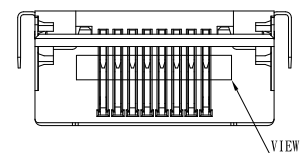
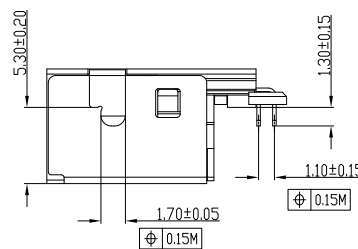
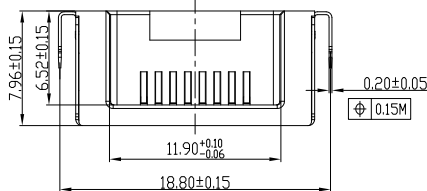
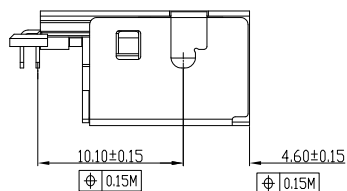

NOTES:

- MATERIAL:
1-1:HOUSING:PA10T+35%GF(VICNYL R635NH);UL 94V-0, COLOR:BLACK
1-2:TERMINAL:PHOSPHOR BRONZE(C5210R-EH);T=0.25mm TREATMENT:
1.GOLD 1μ" MIN ON CONTACT AREA,MATTE SN 50μ" MIN ON SOLDER TAIL,ALL OVER NI 50μ" MIN.
 - SHELL:SUS(201);T=0.20mm,TREATMENT:50μ" NI MIN
 - DEFEND:LCP(E130I);UL 94V-0, COLOR:BLACK
 - CAP:LCP(E130I);UL 94V-0, COLOR:BLACK
- 2.SPECIFICATIONS:
2-1.VOLTAGE RATING:150VAC MAX.
2-2.CURRENT RATING:1.5AMP MAX.
2-3.INSULATION RESISTANCE:500MΩ MIN. AT 500V DC.
2-4.DIELECTRIC WITHSTANDING VOLTAGE:
500V AC 60HZ 1MINUTE.
2-5.DURABILITY:5000 CYCLES.
2-6.OPERATING TEMPERATURE:-30°C TO+70°C.
2-7.FOR REFLOW SOLDERING LEAD-FREE PROCESS.

Part Number(信音)	AU
2RJ1792-011111F	1u"

東莞世華電子有限公司
SHYH HWA ELECTRONICS CO.,LTD.(DONGGUAN)
地址:東莞市塘廈鎮諸佛嶺178工業區
TEL:0769-87910020-1 FAX:0769-87910210

DRAWN BY	王奔	ITEM	半截式 RJ45 PHONE JACK(板上5.30mm)無LED
CHECKED BY		PART NO	CD4531072003
APPROVED BY			

ANGLE PROJECTION	UNIT	mm
	SCALE	1:1
TOLERANCE	DATE	
.X±0.20 .XX±0.10		